



(12) **United States Design Patent**
King et al.

(10) **Patent No.:** **US D755,649 S**
(45) **Date of Patent:** **** May 10, 2016**

- (54) **MULTISPACE PARKING PAY STATION**
- (71) Applicant: **IPS Group Inc.**, San Diego, CA (US)
- (72) Inventors: **David William King**, Rancho Santa Fe, CA (US); **Michael W MacCollum**, Poway, CA (US)
- (73) Assignee: **IPS GROUP INC.**, San Diego, CA (US)
- (**) Term: **14 Years**

6,505,774 B1 *	1/2003	Fulcher et al.	235/381
D472,362 S	3/2003	Zerman et al.	
D481,516 S	10/2003	Magee	
D485,417 S	1/2004	Magee	
D488,280 S	4/2004	Zerman	
D492,080 S	6/2004	Magee	
D492,081 S	6/2004	Magee	
D494,730 S	8/2004	Magee	
D497,814 S	11/2004	dinotsky et al.	
D505,240 S	5/2005	Swaine et al.	

(Continued)

OTHER PUBLICATIONS

U.S. Appl. No. 29/466,268, filed Sep. 5, 2013, Randall et al.

(Continued)

- (21) Appl. No.: **29/477,176**
- (22) Filed: **Dec. 19, 2013**
- (51) **LOC (10) Cl.** **10-03**
- (52) **U.S. Cl.**
USPC **D10/42**
- (58) **Field of Classification Search**
USPC D10/42, 40, 41, 43, 44, 45; D20/1, 2, 8,
D20/9; D99/28, 34
CPC G07F 17/24; G07F 17/242; G07F 17/248;
G07B 15/00; G07B 15/02; G07C 1/30;
G06Q 30/0284
- See application file for complete search history.

Primary Examiner — Martie K Holtje
(74) *Attorney, Agent, or Firm* — Wilson Sonsini Goodrich & Rosati

(57) **CLAIM**

The ornamental design for a multispace parking pay station, as shown and described.

DESCRIPTION

FIG. 1 is a top front perspective view of a multispace parking pay station, showing my new design;
FIG. 2 is a front elevational view thereof;
FIG. 3 is a rear elevational view thereof;
FIG. 4 is a left side elevational view thereof;
FIG. 5 is a right side elevational view thereof;
FIG. 6 is a top plan view thereof; and,
FIG. 7 is a bottom plan view thereof.

The multispace parking pay station housing, depicted by broken lines, has been shown for the purpose of illustrating environment that forms no part of the claimed design.

The circles depicted by broken lines in FIG. 7 have been shown for the purpose of illustrating elements that form no part of the claimed design.

1 Claim, 7 Drawing Sheets

(56) **References Cited**

U.S. PATENT DOCUMENTS

D278,689 S *	5/1985	Jupe	D10/42
5,065,156 A *	11/1991	Bernier	340/932.2
D336,860 S	6/1993	Clough	
D342,209 S	12/1993	Clough	
D360,734 S	7/1995	Hall	
D375,607 S	11/1996	Hall	
D396,655 S	8/1998	Anderson	
D412,289 S	7/1999	Winwood	
D431,788 S	10/2000	Tuxen et al.	
6,230,868 B1 *	5/2001	Tuxen et al.	194/217
6,275,169 B1 *	8/2001	Krygler et al.	340/932.2
D448,910 S	10/2001	Kit	
D450,253 S	11/2001	Marguet	
D454,421 S	3/2002	Jeon	
D460,005 S	7/2002	Jacquet	

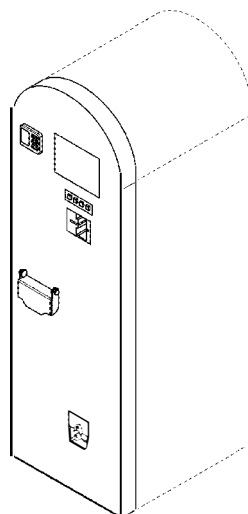

(56)

References Cited

U.S. PATENT DOCUMENTS

D510,751 S 10/2005 Magee et al.
 7,004,385 B1 2/2006 Douglass
 7,019,670 B2* 3/2006 Bahar 340/932.2
 7,028,888 B2 4/2006 Laskowski et al.
 7,040,534 B2 5/2006 Turocy et al.
 D538,505 S 3/2007 Kang
 7,222,782 B2 5/2007 Lute, Jr. et al.
 7,284,692 B1 10/2007 Douglass
 D570,920 S 6/2008 Choi
 7,419,091 B1 9/2008 Scanlon
 D579,795 S* 11/2008 Martinez et al. D10/42
 7,445,144 B2 11/2008 Schlabach et al.
 D582,125 S 12/2008 Kang et al.
 7,533,802 B1 5/2009 McGinley et al.
 D596,374 S 7/2009 Kang
 7,624,919 B2 12/2009 Meek et al.
 7,699,224 B2 4/2010 Molé
 D625,305 S 10/2010 Bleck
 D632,740 S 2/2011 Adeline
 D645,223 S 9/2011 Bleck
 D652,872 S 1/2012 Mougin et al.
 D653,014 S 1/2012 Rohan
 D653,420 S 1/2012 Rohan
 D653,421 S 1/2012 Rohan
 D653,424 S 1/2012 Rohan
 D672,525 S 12/2012 Lee et al.
 D674,985 S 1/2013 Lee
 D677,035 S 2/2013 Lee
 D680,156 S 4/2013 Hernandez et al.
 D681,717 S 5/2013 Helgesson et al.
 D684,745 S 6/2013 Reuter
 D691,165 S 10/2013 Attoma
 D693,983 S 11/2013 Budde et al.
 D696,484 S 12/2013 Lee
 D696,485 S 12/2013 Lee
 D702,913 S 4/2014 Budde
 D702,914 S 4/2014 Budde
 D716,515 S 10/2014 Cha
 D722,740 S 2/2015 Budde
 D724,290 S 3/2015 Cha et al.
 D724,811 S 3/2015 Reitinger
 D724,812 S 3/2015 Cha et al.
 D728,190 S 4/2015 Sheley
 2004/0016796 A1 1/2004 Hanna et al.

2004/0243526 A1* 12/2004 Krygler et al. 705/418
 2004/0262379 A1 12/2004 Gomes et al.
 2005/0029340 A1 2/2005 Ferraro
 2006/0152385 A1* 7/2006 Mandy 340/932.2
 2007/0046651 A1 3/2007 Sinclair et al.
 2007/0276724 A1* 11/2007 Catt 705/13
 2008/0257965 A1 10/2008 Klein et al.
 2008/0265019 A1 10/2008 Artino et al.
 2008/0296365 A1 12/2008 Schliebe
 2009/0057398 A1 3/2009 Douglass et al.
 2010/0161489 A1 6/2010 Goodall et al.
 2010/0187300 A1 7/2010 Ramachandran et al.
 2010/0241564 A1 9/2010 Miller et al.
 2010/0243729 A1 9/2010 Russell et al.
 2011/0133613 A1 6/2011 Descamps et al.
 2012/0286036 A1* 11/2012 Jones et al. 235/380

OTHER PUBLICATIONS

U.S. Appl. No. 29/466,269, filed Sep. 5, 2013, Randall et al.
 U.S. Appl. No. 29/466,267, filed Sep. 5, 2013, Randall et al.
 U.S. Appl. No. 29/477,195, filed Dec. 19, 2013, Randall et al.
 U.S. Appl. No. 29/477,196, filed Dec. 19, 2013, Randall et al.
 U.S. Appl. No. 29/477,200, filed Dec. 19, 2013, Randall et al.
 U.S. Appl. No. 29/477,201, filed Dec. 19, 2013, Randall et al.
 U.S. Appl. No. 29/477,204, filed Dec. 19, 2013, Randall et al.
 U.S. Appl. No. 29/477,321, filed Dec. 20, 2013, Randall et al.
 U.S. Appl. No. 29/477,324, filed Dec. 20, 2013, Randall et al.
 U.S. Appl. No. 29/477,329, filed Dec. 20, 2013, Randall et al.
 U.S. Appl. No. 29/477,339, filed Dec. 20, 2013, Randall et al.
 U.S. Appl. No. 29/477,402, filed Dec. 20, 2013, Randall et al.
 U.S. Appl. No. 29/477,405, filed Dec. 20, 2013, Randall et al.
 U.S. Appl. No. 29/477,200 Office Action dated Apr. 9, 2015.
 U.S. Appl. No. 29/477,201 Office Action dated Apr. 9, 2015.
 U.S. Appl. No. 29/477,204 Office Action dated Apr. 9, 2015.
 U.S. Appl. No. 29/477,402 Office Action dated Apr. 9, 2015.
 U.S. Appl. No. 29/477,324 Office Action dated Apr. 23, 2015.
 U.S. Appl. No. 29/477,321 Office Action dated May 15, 2015.
 U.S. Appl. No. 29/477,329 Office Action dated May 22, 2015.
 Co-pending U.S. Appl. No. 29/545,046, filed Nov. 9, 2015.
 Co-pending U.S. Appl. No. 29/545,062, filed Nov. 9, 2015.
 Co-pending U.S. Appl. No. 29/548,020, filed Dec. 9, 2015.
 Co-pending U.S. Appl. No. 29/548,022, filed Dec. 9, 2015.
 Co-pending U.S. Appl. No. 29/548,023, filed Dec. 9, 2015.
 Co-pending U.S. Appl. No. 29/548,024, filed Dec. 9, 2015.

* cited by examiner

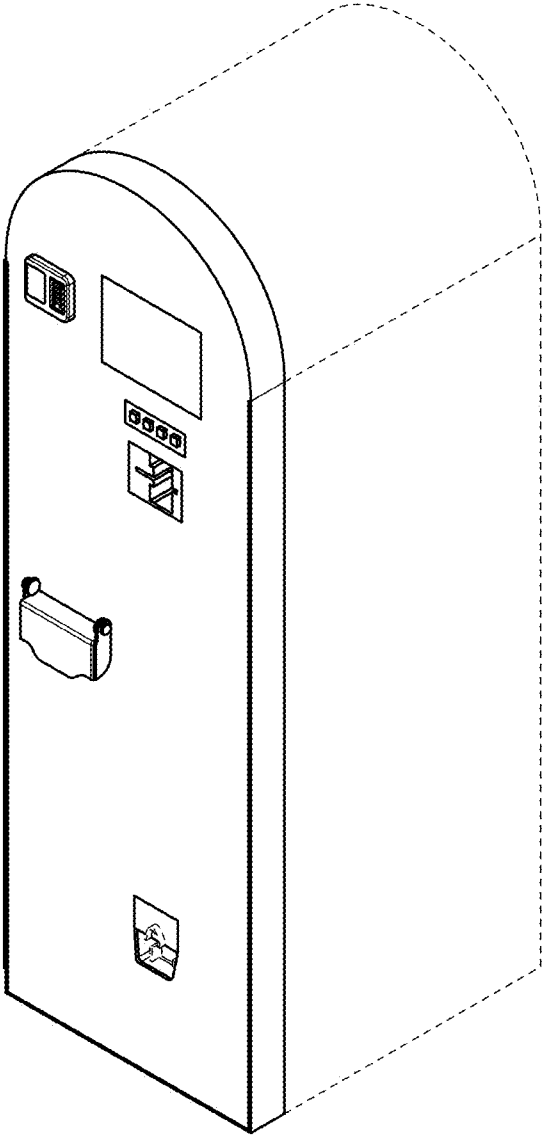

FIG. 1

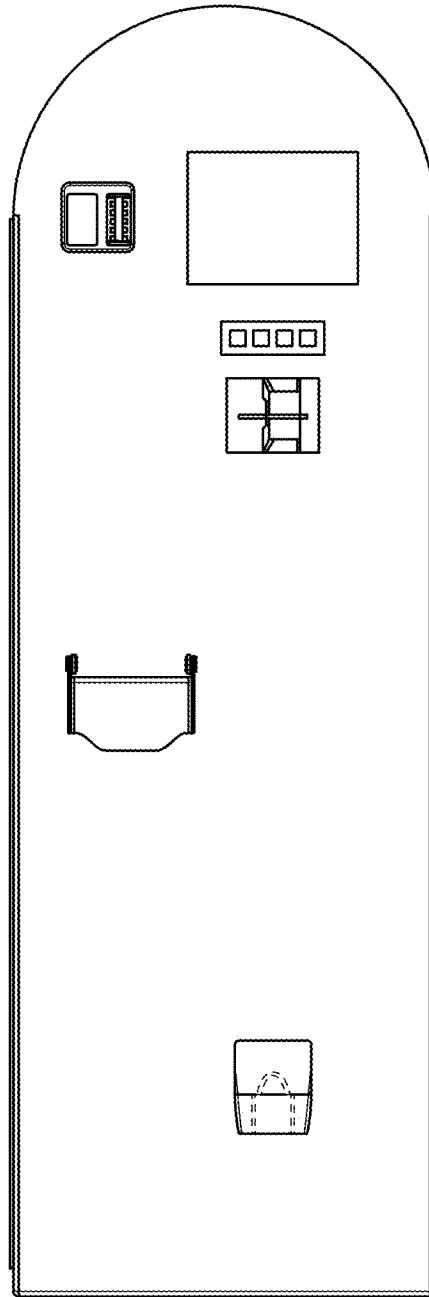

FIG. 2

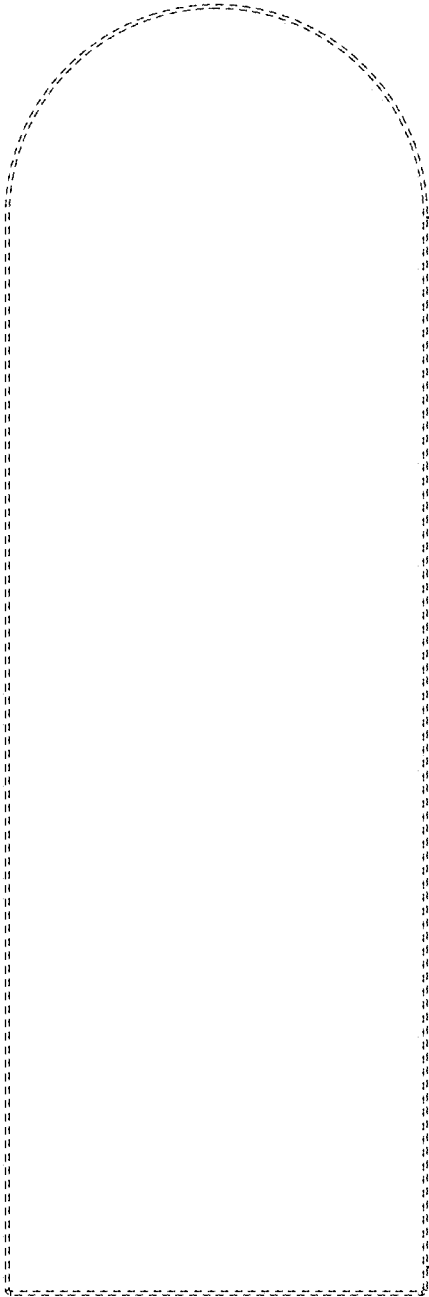

FIG. 3

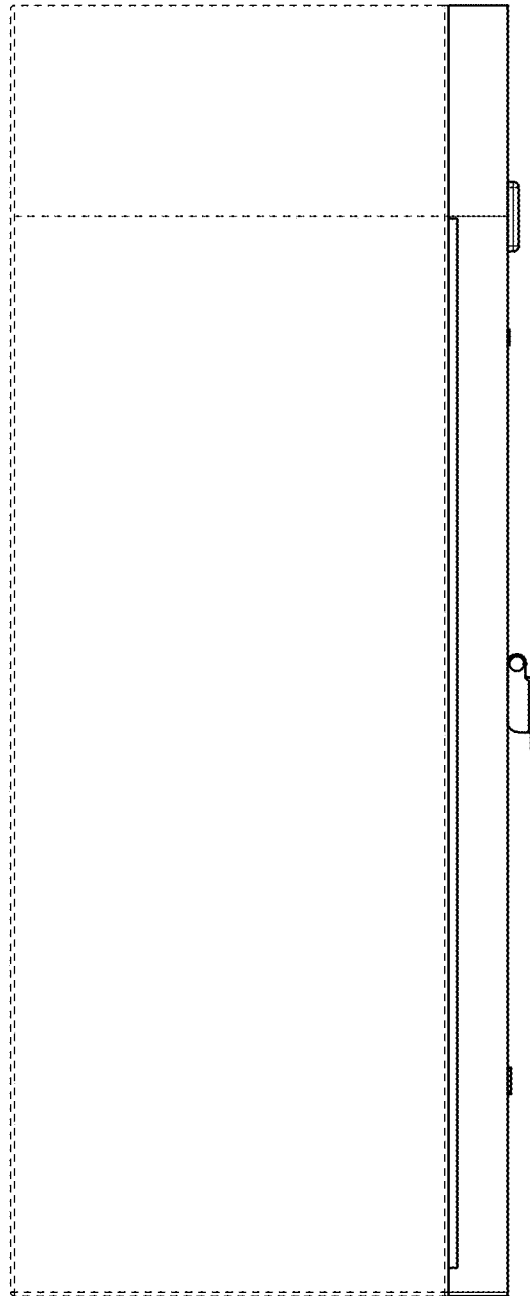

FIG. 4

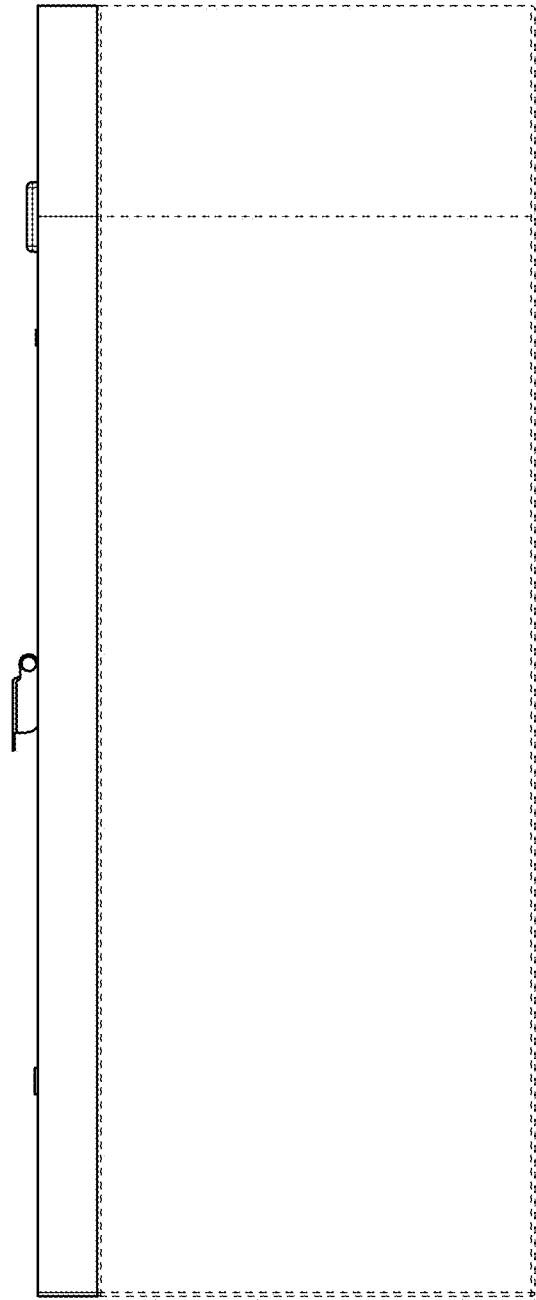

FIG. 5

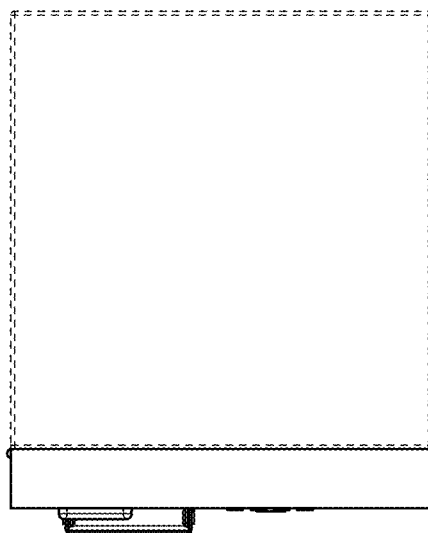

FIG. 6

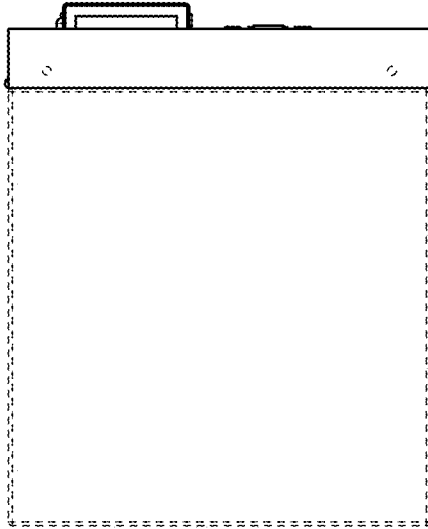

FIG. 7